

OVERLUX LINE



Wood/Aluminium Windows and French Doors



OVERLUX series



Wood/Aluminium Windows
and French Doors

Spaces that adapt to your lifestyle.

Introducing **OVERLUX LINE**, a wood-aluminium window with a geometric, balanced, and more traditional design—perfect for those seeking an elegant, functional, and timeless window solution.

The interior in wood brings warmth, authenticity, and customization options, harmoniously integrating into any environment. The exterior in aluminium, characterized by clean lines and precise proportions, ensures durability, solidity, and a subtle aesthetic that fits both classic and modern settings.

OVERLUX LINE can be made with double glazing or, for higher performance needs, with triple glazing. The double-glass version provides excellent insulation and a lightweight construction, while the triple-glass configuration offers superior thermal efficiency and acoustic comfort, allowing you to choose the solution that best suits your home.

Every detail is designed to enhance natural light and improve the liveability of spaces, creating a harmonious connection between interior and exterior. The result is a window that is not only functional but also a feature that enriches and defines the environment.

OVERLUX LINE represents the fusion of tradition, quality, and technology, delivering a window that is beautiful, high-performing, and tailored to your lifestyle.

GEOMETRIC DESIGN AND TRADITIONAL STYLE



ESSENTIAL LINES WITH BALANCED, TRADITIONAL PROFILES



CUSTOMIZABLE WOODEN INTERIOR TO HARMONIZE WITH ANY ENVIRONMENT



DURABLE ALUMINIUM EXTERIOR WITH A CLEAN, MODERN LOOK



OPTION FOR DOUBLE OR TRIPLE GLAZING FOR ENHANCED THERMAL AND ACOUSTIC COMFORT



OVERLUX LINE

INTERIOR VIEW

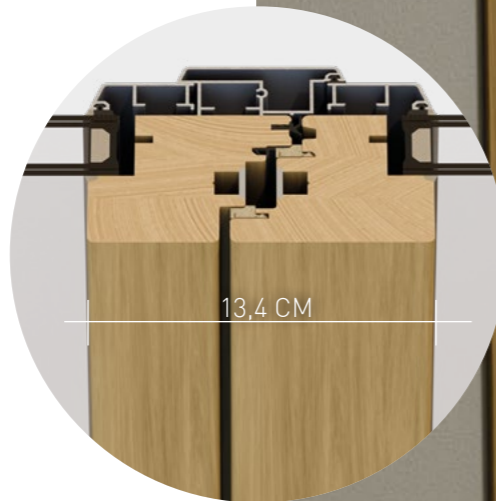

CENTRAL
NODE OPTIONS
CHOOSE FROM
3 AVAILABLE
MODELS

HINGES CAN BE EITHER
VISIBLE OR CONCEALED.

AVAILABLE
WITH DOUBLE
GLAZING
OR TRIPLE
GLAZING

SASH PROFILE VERY
MINIMALIST SASH PROFILE
WITHOUT VISIBLE GLAZING
BEAD, CUSTOMIZABLE IN 3
SHAPES.

CLEAN LINES AND
SIMPLICITY THANKS TO THE
FRAME WITH INTEGRATED
FLANGE.

STANDARD LOW
ALUMINIUM THRESHOLD
FOR FRENCH DOORS.



OVERLUX LINE

EXTERNAL VIEW



LOW-PROFILE ALUMINUM THRESHOLD



EXTERIOR VIEW WITH CLEAN, GEOMETRIC LINES*

DOUBLE OR TRIPLE GLAZING

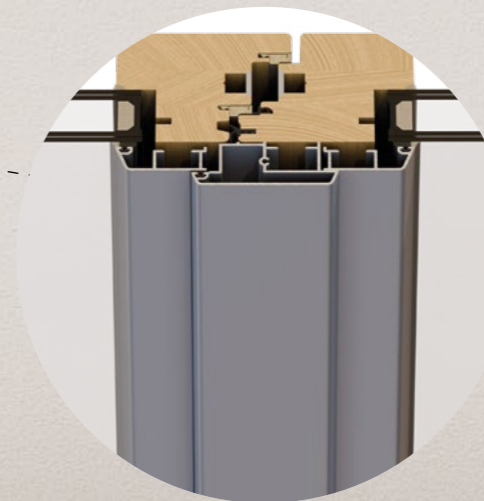

CENTRAL NODE ON THE EXTERIOR SIDE. AVAILABLE IN 3 VERSIONS.

*Example of application on sub-frame

— OVERLUX LINE



CLEAN AND
MINIMAL LINES.

Features



DESCRIPTION

Inside, the window frame is made of **three-layer laminated wood**, available in premium species such as **pine, fir, oak, okoumé**, or others upon request, providing warmth, naturalness, and an authentic aesthetic that blends seamlessly with any interior style.

Outside, **the aluminium cladding** offers excellent protection against the elements, ensuring long-lasting durability and a refined, clean, and contemporary look. Designed for those seeking solidity, performance, and beauty, **OVERLUX LINE** provides excellent thermal and acoustic insulation, with options for double or triple glazing, delivering comfort in every season and the perfect combination of the warm character of wood and the strength of aluminium.



WOOD PROTECTION

Protective treatment with a **cycle based on acrylic resin in aqueous emulsion**, applied in three to six coats depending on the desired finish and level of protection. Natural or pigmented finishes are available to enhance the wood grain or to harmonize with any architectural style.



DIMENSIONS

- Fixed frame in laminated wood: nominal section 64.5 × 70 mm.
- Movable sash in laminated wood: nominal section 68 × 79 mm.



HARDWARE

Standard hardware features an advanced locking system with anti-burglary locking points distributed along the entire perimeter, providing continuous and effective protection. Includes tilt-and-turn function, micro-ventilation, lever rod, and mechanisms designed for smooth operation, long-lasting durability, and maximum user comfort. A complete set, engineered for safe, practical, and quiet daily use.



SEALING AND WEATHERPROOFING

Compression-seal system with high-resistance polyurethane foam gaskets applied around the entire perimeter of the frame. Flexible and weather-resistant, they provide an excellent barrier against **air, water, and noise**, ensuring long-lasting thermal and acoustic performance and maintaining effective adhesion even after prolonged use.



INSULATED GLASS UNIT

Designed for double or triple high-performance glazing, **OVERLUX LINE** ensures excellent thermal performance and consistent indoor comfort throughout the year. The standard use of Argon gas and Warm Edge spacers helps minimize heat loss and enhances the overall insulation of the window. The available range of glass units includes low-emissivity, solar-control, soundproof, and safety options, as well as satin or decorative variants, allowing full customization of both aesthetics and functionality. **OVERLUX LINE** adapts to diverse design requirements, offering an ideal balance of performance, versatility, and build quality.



THERMAL TRANSMITTANCE*

Thermal insulation can reach a U_w value of up to 1.05 W/m²K.

*Thermal values are calculated according to UNI EN ISO 10077-1 and 2 standards, based on a single-leaf spruce wood window measuring 1230 × 1480 mm (according to UNI EN 14351-1), with a low-emissivity double glazing unit having a U_g value of 0.7 W/m²K.



SOUND INSULATION

Acoustic reduction **from 31 dB up to 43 dB**, depending on the type of glass selected. **Special acoustic glass** options are available for higher soundproofing requirements, including custom solutions outside the standard range.



Window – Interior View

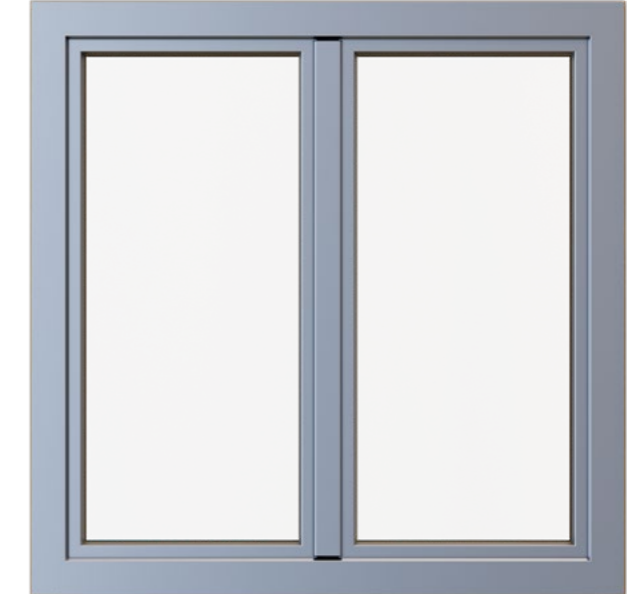

Window – Exterior View



Window – Interior Corner



Window – Exterior Corner

— OVERLUX LINE



A SYNTHESIS OF ART
AND TECHNOLOGY

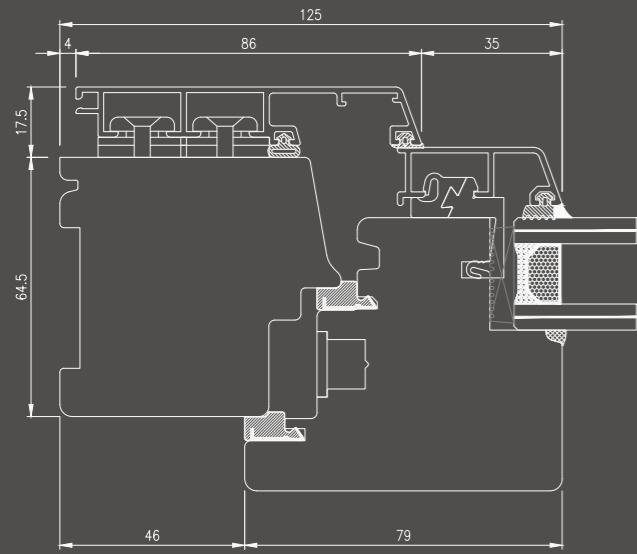

Top/Side Node - Window and French Door

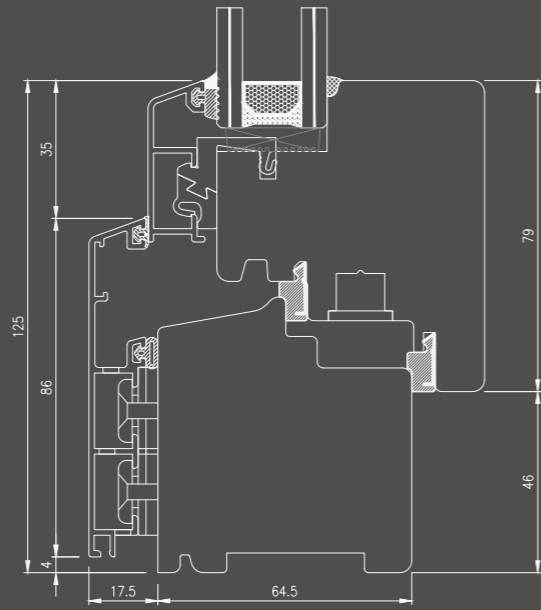

Standard Bottom Node - Window with Integrated Drip Cap

A5 (standard)

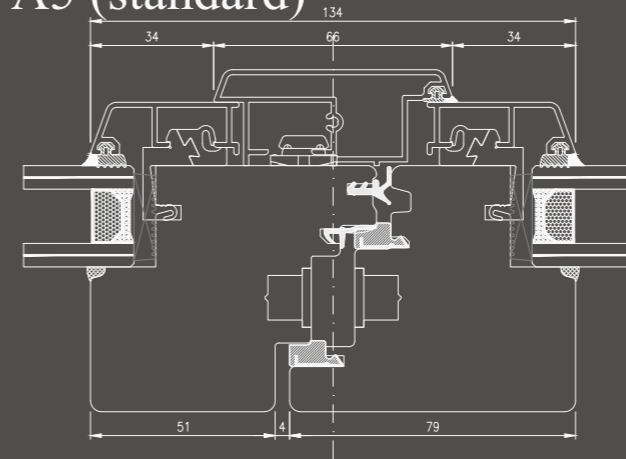

Central Node - Window/French Door

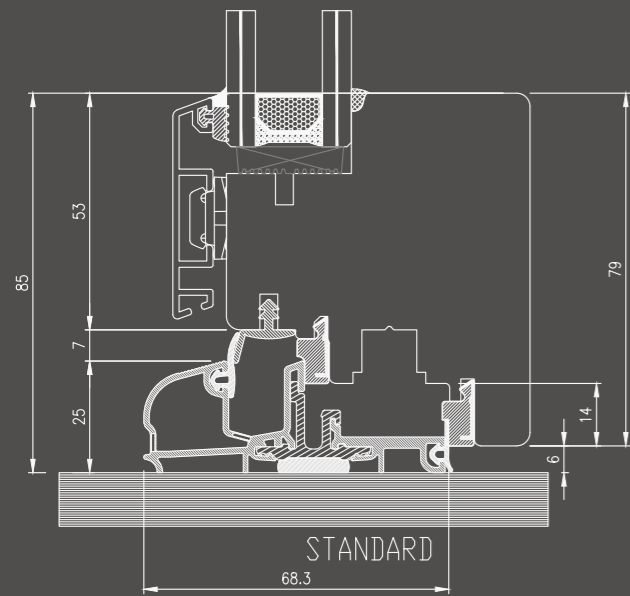
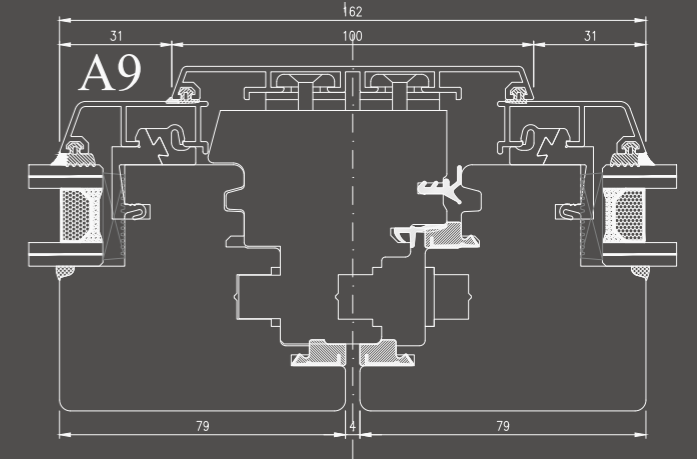

Bottom Node - French Door with Threshold

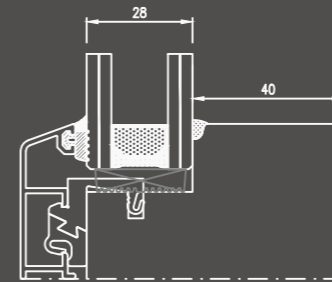
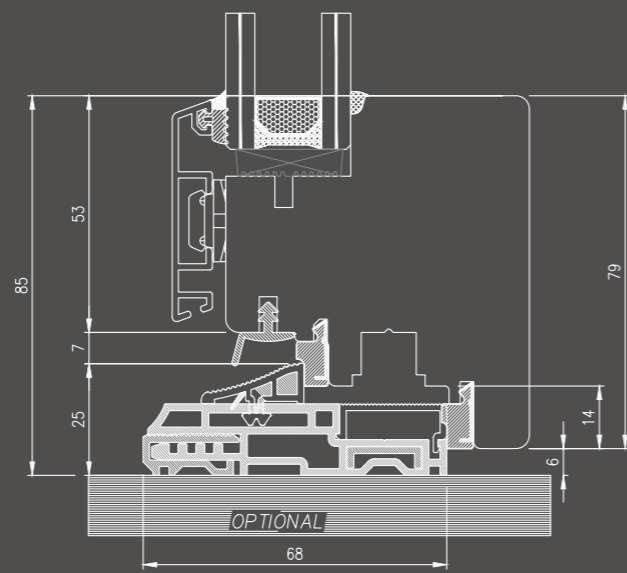

SQUARE

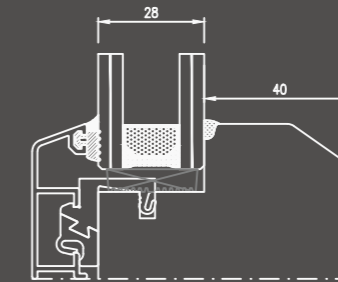

CHAMFERED

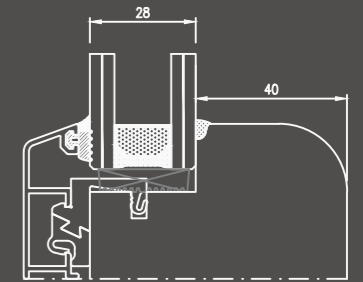

ROUNDED

Type of internal sash profile

Key Strengths





CUSTOM FINISHES

Alle 32 finiture di serie a scelta sul legno, con possibilità di ulteriori personalizzazioni, si uniscono le molteplici scelte per la colorazione della cover in alluminio esterna che può variare da un Ral a scelta ad un effetto legno. La cover esterna è saldata negli angoli per una migliore estetica e durabilità nel tempo (solo nelle colorazione a tinta unita).







STANDARD WARRANTY*

-  Window functionality – 10 YEARS
-  No internal fogging of insulated glass units – 10 YEARS
-  No delamination of laminated profiles in wooden or wood/aluminium windows – 10 YEARS

* See the conditions listed in the warranty certificate and the provisions of Article 5 of the general sales conditions
 ** According to the values defined by ISO 4628-2-4-5, UNI EN 13722, UNI 8941-1-2-3 standards



PREMIUM*

-  Window functionality – 10 YEARS
-  Durability of paint on long-life painted windows (RAL 9001, 9010, 9016, 1013) – 15 YEARS**
-  Durability of paint on long-life dark-stained windows – 10 YEARS**
-  No internal fogging of insulated glass units – 10 YEARS
-  No delamination of laminated profiles in wooden or wood/aluminum windows – 10 YEARS



DESIGN

Our windows feature a contemporary aesthetic, reflecting a clear and modern language of form. The construction systems are state-of-the-art, with meticulous attention to detail, and are adaptable to any environment to meet the individual and functional needs of our clients.

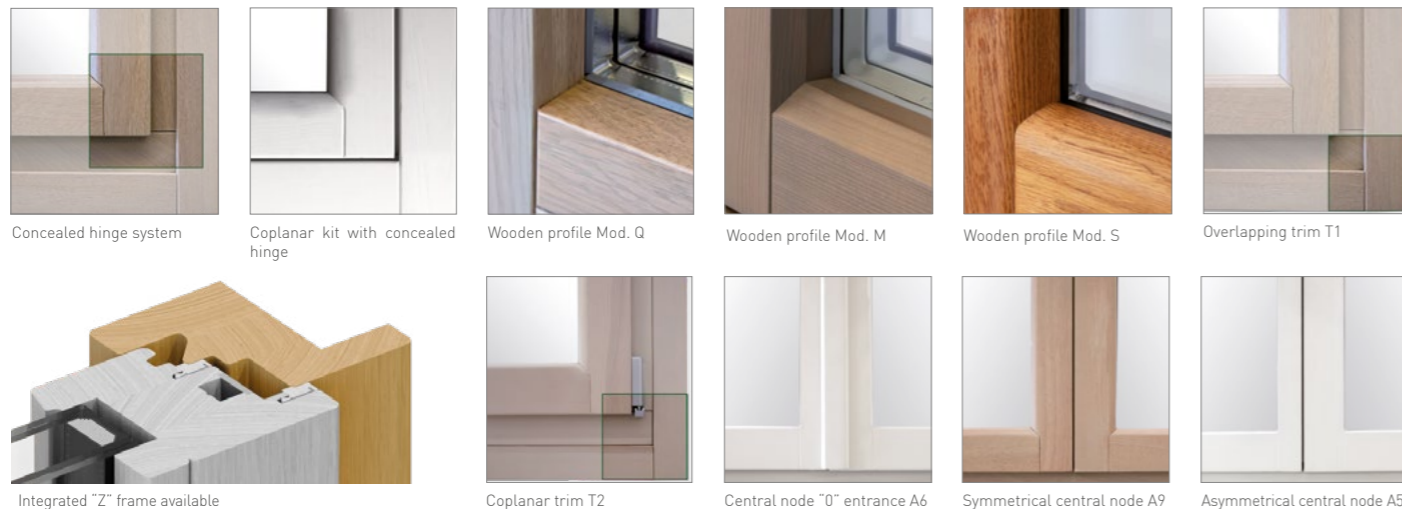

Concealed hinge system Coplanar kit with concealed hinge Wooden profile Mod. Q Wooden profile Mod. M Wooden profile Mod. S Overlapping trim T1

Integrated "Z" frame available Coplanar trim T2 Central node "0" entrance A6 Symmetrical central node A9 Asymmetrical central node A5



ENERGY SAVINGS

Waterproofing, high-performance profiles, glass with synthetic spacers, gaskets, and installation without thermal bridges all contribute significantly to energy efficiency, resulting in noticeable savings on utility bills.

Finishes

RANGE 1 STANDARD

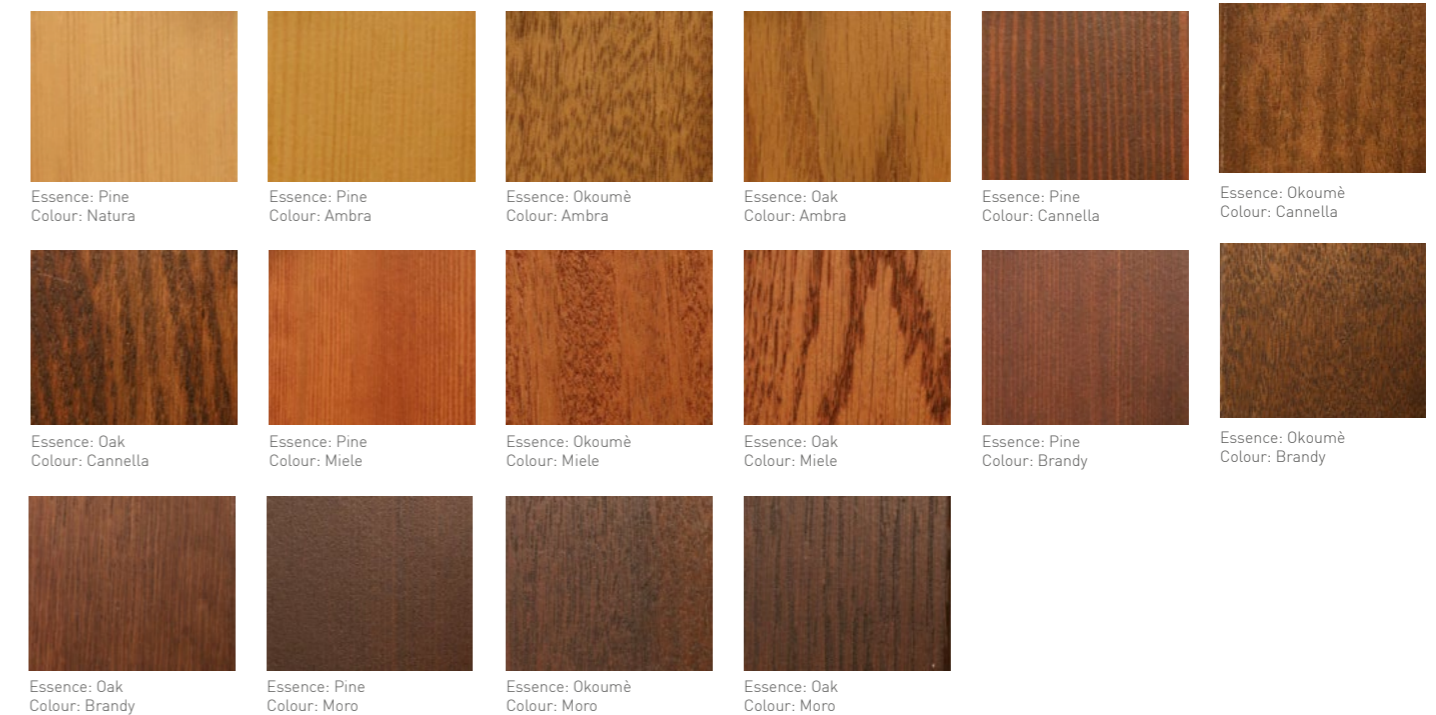

Essence: Pine Colour: Natura Essence: Pine Colour: Ambra Essence: Okoumè Colour: Ambra Essence: Oak Colour: Ambra Essence: Pine Colour: Cannella Essence: Okoumè Colour: Cannella

Essence: Oak Colour: Cannella Essence: Pine Colour: Miele Essence: Okoumè Colour: Miele Essence: Oak Colour: Miele Essence: Pine Colour: Brandy Essence: Okoumè Colour: Brandy

Essence: Oak Colour: Brandy Essence: Pine Colour: Moro Essence: Okoumè Colour: Moro Essence: Oak Colour: Moro

RANGE 2 - WITH SURCHARGE

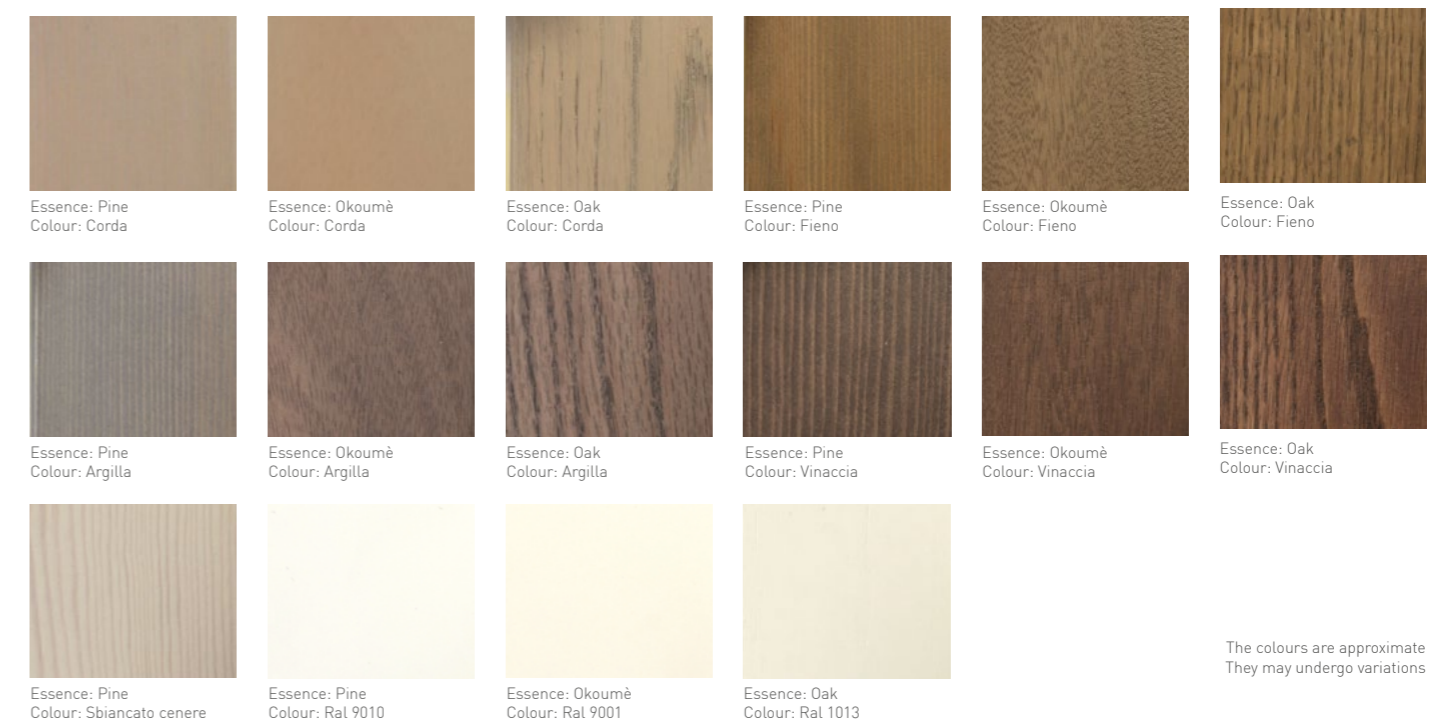

Essence: Pine Colour: Corda Essence: Okoumè Colour: Corda Essence: Oak Colour: Corda Essence: Pine Colour: Fieno Essence: Okoumè Colour: Fieno Essence: Oak Colour: Fieno

Essence: Pine Colour: Argilla Essence: Okoumè Colour: Argilla Essence: Oak Colour: Argilla Essence: Pine Colour: Vinaccia Essence: Okoumè Colour: Vinaccia Essence: Oak Colour: Vinaccia

Essence: Pine Colour: Sbiancato cenere Essence: Pine Colour: Ral 9010 Essence: Okoumè Colour: Ral 9001 Essence: Oak Colour: Ral 1013

The colours are approximate They may undergo variations

OTHER COLOURS ON REQUEST.

Opening Types

FIXED WINDOWS

WITH GLAZING BEAD



SCREW-MOUNTED CASEMENT



FIXED SECTIONS FRENCH DOOR

WITH GLAZING BEAD



WINDOWS

WASISTAS



1 LEAF / SINGLE CASEMENT



2 LEAVES / DOUBLE CASEMENT



3 LEAVES / TRIPLE CASEMENT

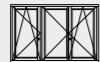

FRENCH DOORS

1 LEAF / SINGLE DOOR



2 LEAVES / DOUBLE DOOR



3 LEAVES / TRIPLE DOOR



FRENCH DOORS WITH LOCK

1 LEAF / TILT & TURN



1 LEAF / SINGLE DOOR



2 LEAVES / DOUBLE DOOR



TILT WINDOW

HORIZONTAL



TILT-AND-SLIDE WINDOW

SLIDING / FIXED



SLIDING / TILT



TILT-AND-SLIDE FRENCH DOOR

SLIDING / FIXED



SLIDING / TILT



LIFT-AND-SLIDE DOORS**

OPENABLE / FIXED



OPENABLE / OPENABLE



1 LEAF OUTSIDE WALL



2 LEAVES OUTSIDE WALL



1 LEAF INSIDE WALL



2 LEAVES INSIDE WALL

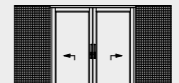

FIXED / OPENABLE / FIXED



OPENABLE / FIXED / OPENABLE



FIXED / OPENABLE / OPENABLE / FIXED



OPENABLE / OPENABLE / OPENABLE / OPENABLE



LOW ARCH*

FIXED



1 LEAF



2 LEAVES



3 LEAVES



FULL SEMI-CIRCLE ARCH*

FIXED



1 LEAF



2 LEAVES



3 LEAVES



DOUBLE RADIUS ARCH*

FIXED



1 LEAF



2 LEAVES



3 LEAVES



PORTHOLE*

FIXED



TOP HALF OPENABLE
BOTTOM HALF FIXED



TRAPEZOID

FIXED



1 LEAF



2 LEAVES



3 LEAVES



PENTAGON

FIXED



1 LEAF



2 LEAVES



3 LEAVES

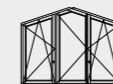

BEVELED

FIXED



1 SASH



TRIANGLE

FIXED



1 SASH



* Curvature radii to be verified with the technical office

**Lift-and-slide windows for the LINE system will be executed using the Sky Wood-Clad and Nexis-Clad systems



GIEMME
Italian Windows Design



Windows. Stories. Projects.

For technical, constructional, and typographical reasons, colors, descriptions, technical and dimensional details, as well as any other information included in this catalog, may be changed without notice, also depending on technological developments or the availability of certain materials and/or components. To avoid any misunderstandings with its customers, Giemme Forti Srl invites you to verify all characteristics of its products at authorized sales points. VERS. OVERLINE / PRINT 09-25

GIEMME.NET • INFO@GIEMME.NET